

## INTEGRATED AMPLIFIER

**SERVICE MANUAL**

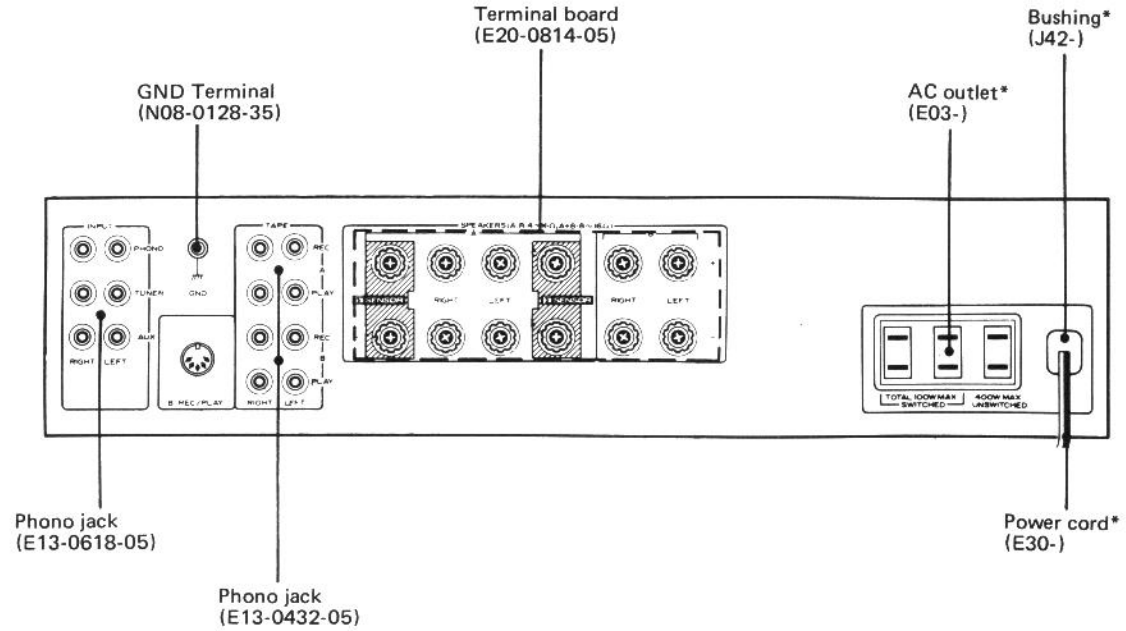
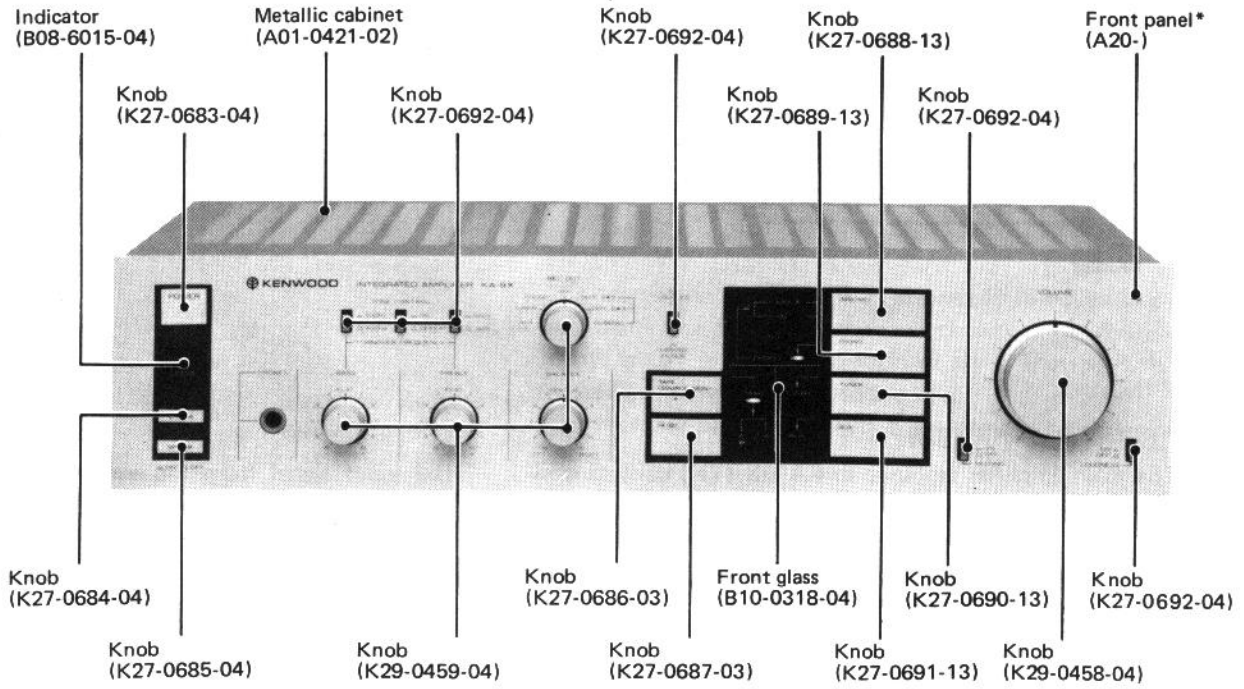

\* Refer to Parts List on page 11.

## BLOCK & LEVEL DIAGRAM/CIRCUIT DESCRIPTION

### BLOCK & LEVEL DIAGRAM

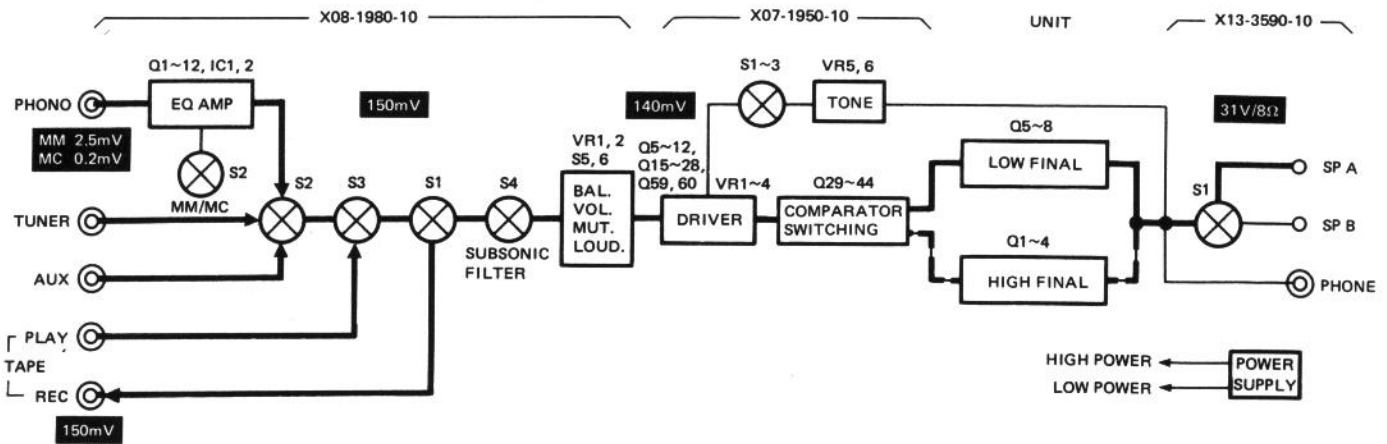

### CIRCUIT DESCRIPTION

The main amplifier employed in KA-9X (7X) consists of a 3-stage differential class A voltage amplifier and a 3-stage Darlington class B SEPP. Unlike the conventional circuit configuration, the final stage has a couple of circuits: one for low voltages and one for high voltages. During normal operation, transistors (Q5~Q8) on the low-voltage side perform their function, reducing the heat generation and power consumption of the amplifier (Refer to "Heat Generation and Power consumption of Amplifier" on the next page). During high power output operation, transistors (Q1~Q4) on the high-voltage side become active, ensuring optimum operation of the amplifier with minimum heat generation. For optimizing the amplifier operation, a comparator circuit, holding circuit, and distributor circuit, consisting of Q29~Q44, are also provided.

The following explains the amplifier operation at the positive side of channel L (see Figure 1).

The input signal from the emitter Q25 enters the distributor circuit Q29/Q33. Normally, Q33 is turned on by R77 and transfers the input signal to Q5 on the low-voltage side. If the input signal level is higher than the reference voltage  $V_x$  (approximately 30V) of the comparator Q41, Q41 is turned on through the emitter of Q5 and D15. At the same time, Q37 of the holding circuit turns on, causing Q29 of the distributor circuit to turn on. When Q29 turns on, the Q33 base-emitter bias becomes zero, turning off Q33. Then, the input signal is transmitted to Q1 on the high-voltage side, allowing high power output operation. D11 and R73 are provided to impart hysteresis characteristic ( $V_x \rightarrow V_x'$ , approximately 23V) to the comparator circuit and ensure distribution operation. D15 is provided for the comparator Q41, which normally has an inverse bias. The holding circuit (Q37, C27, R91 and R95) keeps Q29 on for a certain period of time (t), enabling operation of the high-voltage side. This circuit inhibits the distributor circuit operation if the input signal level and frequency are substantially high, and thereby prevents the distortion factor from deteriorating.

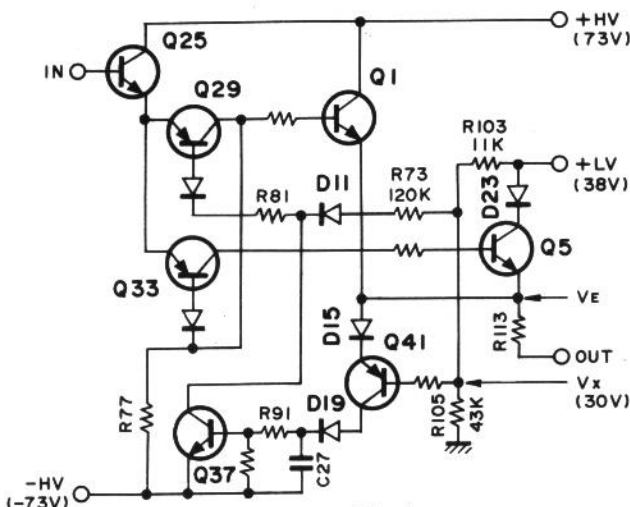

Fig. 1

# CIRCUIT DESCRIPTION

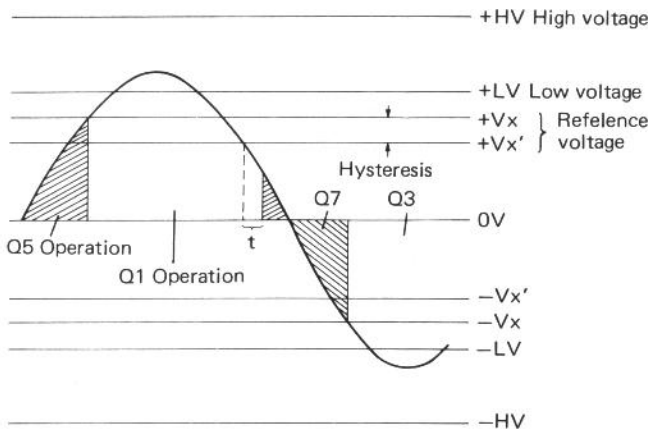

Fig. 2 50Hz, 60W Output waveform

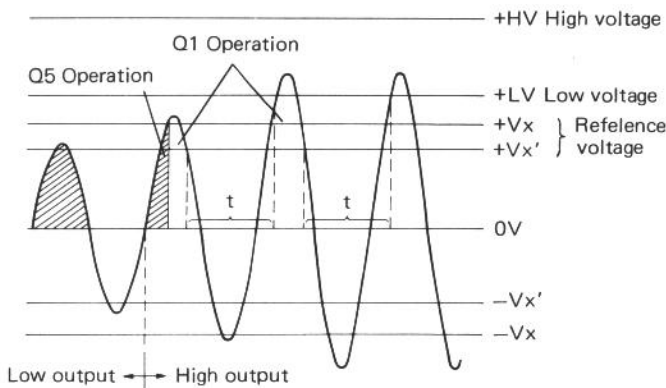

Fig. 3 1kHz Output waveform

### Heat Generation and Power Consumption of Amplifier

The main amplifier which drives the speaker provides the speaker with electric energy, which is converted into acoustic energy by the speaker. This conversion of energy requires the operation called power amplification. Since in reality perfect power amplification is impossible (the theoretical efficiency for class B amplifier is 78.5%), substantial amounts of heat are generated in process.

Typical heat generating parts are:

- (1) Final transistor
- (2) Power transformer
- (3) Power circuit (rectifying diodes, etc.)
- (4) Lamps, etc.

The following explanation is concerned with item (1), above. Consider a class B SEPP circuit as shown in Figure 4. The power consumption  $P_c$  of each of the transistors can be expressed as the product of the collector current  $I_c$  and the collector-emitter voltage  $V_{CE}$ . Thus,

$$P_c = I_c \times V_{CE} \dots\dots\dots(1)$$

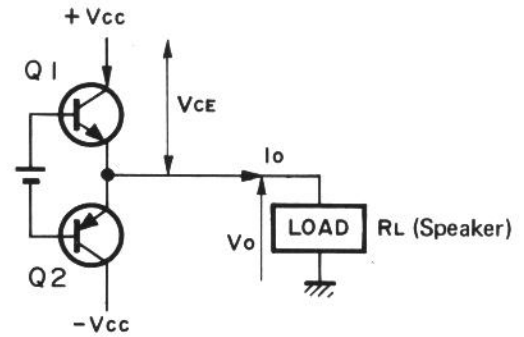

Fig. 4 SEPP Circuit

The instantaneous value of  $P_c$  expressed in equation (1) represents the transistor power consumption at given instant, which is lost in the form of heat. That is,  $P_c$  is a wasted power not supplied to the load.

On the other hand, the power  $P$  supplied to the load is calculated by the following equation:

$$P_o = I_o \times V_o \dots\dots\dots(2)$$

Assuming the amplifier output voltage  $V_o$  as having a sine wave ( $V_o = V_o \sin \omega t$ ) and ignoring idle current, the wave forms of the output voltage  $V_o$  and output current  $I_o$  appear as shown in Figure 5. (For simplicity, the load is assumed as a pure resistor.)

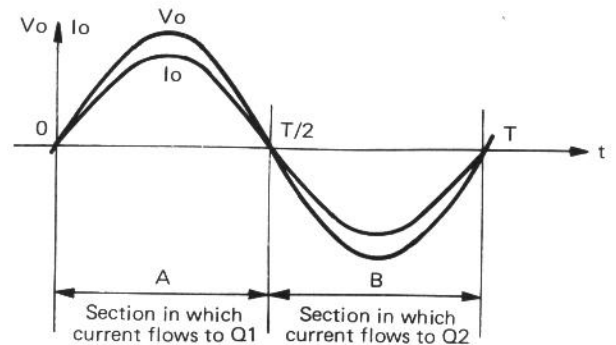

Fig. 5 SEPP Circuit output current/voltage

The power consumption of Q1 alone is calculated as follows:

$$P_c = I_c \times (V_{cc} - V_o)$$

**CIRCUIT DESCRIPTION**

Since  $I_o = I_c$  in section A and  $I_c = 0$  in section B (see Figure 5), the actual power consumption irradiated as heat is the time average of  $P_c$  ( $\overline{P_c}$ ), which is calculated as follows :

$$\begin{aligned} \overline{P_c} &= \frac{1}{T} \int_0^T P_c dt \\ &= \frac{1}{T} \int_0^{\frac{T}{2}} I_o (V_{CC} - V_o) dt + \int_{\frac{T}{2}}^T 0 dt \\ &= \frac{1}{T} \int_0^{\frac{T}{2}} \frac{V_o}{R_L} \sin \omega t (V_{CC} - V_o \sin \omega t) dt \\ &= \frac{1}{T} \int_0^{\frac{T}{2}} \frac{V_{CC} V_o}{R_L} \sin \omega t dt - \frac{1}{T} \int_0^{\frac{T}{2}} \frac{V_o^2}{R_L} \sin^2 \omega t dt \\ &= \frac{1}{2R_L} \left( \frac{2}{\pi} V_{CC} V_o - \frac{V_o^2}{2} \right) \end{aligned}$$

To obtain the maximum value of  $\overline{P_c}$ ,  $\overline{P_c}$  is differentiated by  $V_o$  as follows :

$$\frac{d\overline{P_c}}{dt} = \frac{1}{2R_L} \left( \frac{2}{\pi} V_{CC} - V_o \right)$$

Thus,  $\overline{P_c}$  becomes maximum when  $V_o = 2/\pi V_{CC}$ .

$$\overline{P_{c \max}} = \frac{1}{\pi^2} \frac{V_{CC}}{R_L}$$

The greater the power supply voltage  $V_{CC}$ , the greater becomes the  $\overline{P_{c \max}}$ . Similarly, since the time average of  $P_o$  ( $\overline{P_o}$ ) is supplied to the load,  $\overline{P_o}$  is calculated as follows :

$$\begin{aligned} \overline{P_o} &= \frac{1}{T} \int_0^T I_o \times V_o dt \\ &= \frac{1}{T} \int_0^{\frac{T}{2}} \frac{V_o^2}{R_L} \sin^2 \omega t dt \end{aligned}$$

$$\overline{P_o} = \frac{V_o^2}{2R_L}$$

Needless to say, the power supplied to the load becomes maximum when  $V_o = V_{CC}$ . Hence,

$$\overline{P_{o \max}} = \frac{V_{CC}^2}{2R_L}$$

Namely,

$$\frac{\overline{P_{c \max}}}{\overline{P_{o \max}}} = \frac{2}{\pi^2} \doteq 0.203 \dots$$

Assuming  $\overline{P_o}$  at  $V_o = 2V_{CC}/\pi$  as  $\overline{P_{o1}}$

$$\overline{P_{o1}} = \frac{4}{\pi^2} \cdot \frac{V_{CC}^2}{2R_L} \doteq 0.405 \overline{P_{o \max}}$$

Thus,  $P_c$  of a single output transistor of class B SEPP becomes maximum when the output is approximately 40% of the full power, the maximum value being approximately 20% of the full power.

Note that it is normally necessary to pass an idle current (approximately 20 to 100mA). This current also increases in proportion to the voltage. Note also that if the load is not a pure resistor, but has a reactance component (e.g., speaker load), a reactive power component occurs. This reactive power should be consumed by the amplifier, hence the amount of heat generated inside the amplifier (output transistor) further increases.

Since  $P_c$  is proportional to the full power, amplifiers whose full power is smaller (i.e., amplifiers with lowerpower supply voltage) produce smaller amounts of heat. This means that the amount of heat generated by the final transistor and the radiator size can be reduced by using an amplifier of low power supply voltage during normal operation and by operating another amplifier of high power supply voltage only when a high output is required.

Also, by using the same winding for the power transformer to pick up both high and low voltages, it is possible to reduce the transformer internal loss and the transformer size, since the current does not constantly flow through the high-voltage side. The power transformer and radiator occupy the greater part of the amplifier weight, space, and cost. The reduction in size of these components means, therefore that an amplifier of greater power output can be offered to users at a lower cost.

## ADJUSTMENT/REGLAGE/ABGLEICH

## ADJUSTMENT

NO.	ITEM	INPUT SETTINGS	OUTPUT SETTINGS	AMPLIFIER SETTINGS	ALIGNMENT POINTS	ALIGN FOR	FIG.
1	OFFSET	—	Connect a DC voltmeter to SPEAKER A terminals.	SPKR : A VOLUME : 0	VR1 (L) VR2 (R)	0V	
2	IDLE CURRENT	—	Connect a DC voltmeter across R113 (L), R114 (R)	SPKR : OFF VOLUME : 0	VR3 (L) VR4 (R)	8mV	

## REGLAGE

No	ITEM	REGLAGE DE L'ENTREE	REGLAGE DE LA SORTIE	REGLAGE DE L'AMPLIFICATEUR	POINTS L'ALIGNMENT	ALIGNER POUR	FIG.
1	OFFSET	—	Brancher le voltmètre de CC aux bornes de sortie + et —. (SPKR : A)	SPKR : A VOLUME : 0	VR1 (L) VR2 (R)	0V	
2	REGLAGE DU COURANT DE POLARISATION	—	Conneter un voltmètre CC sur R113 (L), R114 (R).	SPKR : OFF VOLUME : 0	VR3 (L) VR4 (R)	8mV	

## ABGLEICH

NR.	GEGENSTAND	EINGANGS-EINSTELLUNG	AUSGANGS-EINSTELLUNG	VORSTÄRKER EINSTELLUNG	ABGLEICH-PUNKTE	ABGEICHEN FÜR	ABB.
1	OFFSET	—	Einen Gleichspannungsmesser über SPKR : A anschließen.	SPKR : A VOLUME : 0	VR1 (L) VR2 (R)	0V	
2	LEERLAUFS	—	Einen Gleichspannungsmesser über R113 (L), R114 (R) anschließen.	SPKR : OFF VOLUME : 0	VR3 (L) VR4 (R)	8mV	

**Note :**

A self-restoring thermal switch is built into the power transformer. This switch is activated to cut output of the transformer when its temperature rises beyond 150° C. The amount of time required for recovery is approximately 5 minutes.

**Remarque :**

Un commutateur thermique à auto-déclenchement est incorporé au transformateur de puissance. Ce commutateur est activé pour couper l'alimentation du transformateur lorsque sa température s'élève au dessus de 150° C. Cinq minutes sont environ nécessaires pour que le transformateur soit de nouveau mis sous tension.

**Bemerkung :**

Ein Rückstell-Thermoschalter ist in den Netztransformator eingebaut. Der Schalter wird aktiviert, wenn seine Temperatur über 150° ansteigt, wobei der Transformatorausgang abgetrennt wird. Die zur Erholung erforderliche Zeit beträgt ca. 5 Minuten.



# PC BOARD

POWER AMP (X07-1950-10) Component side view

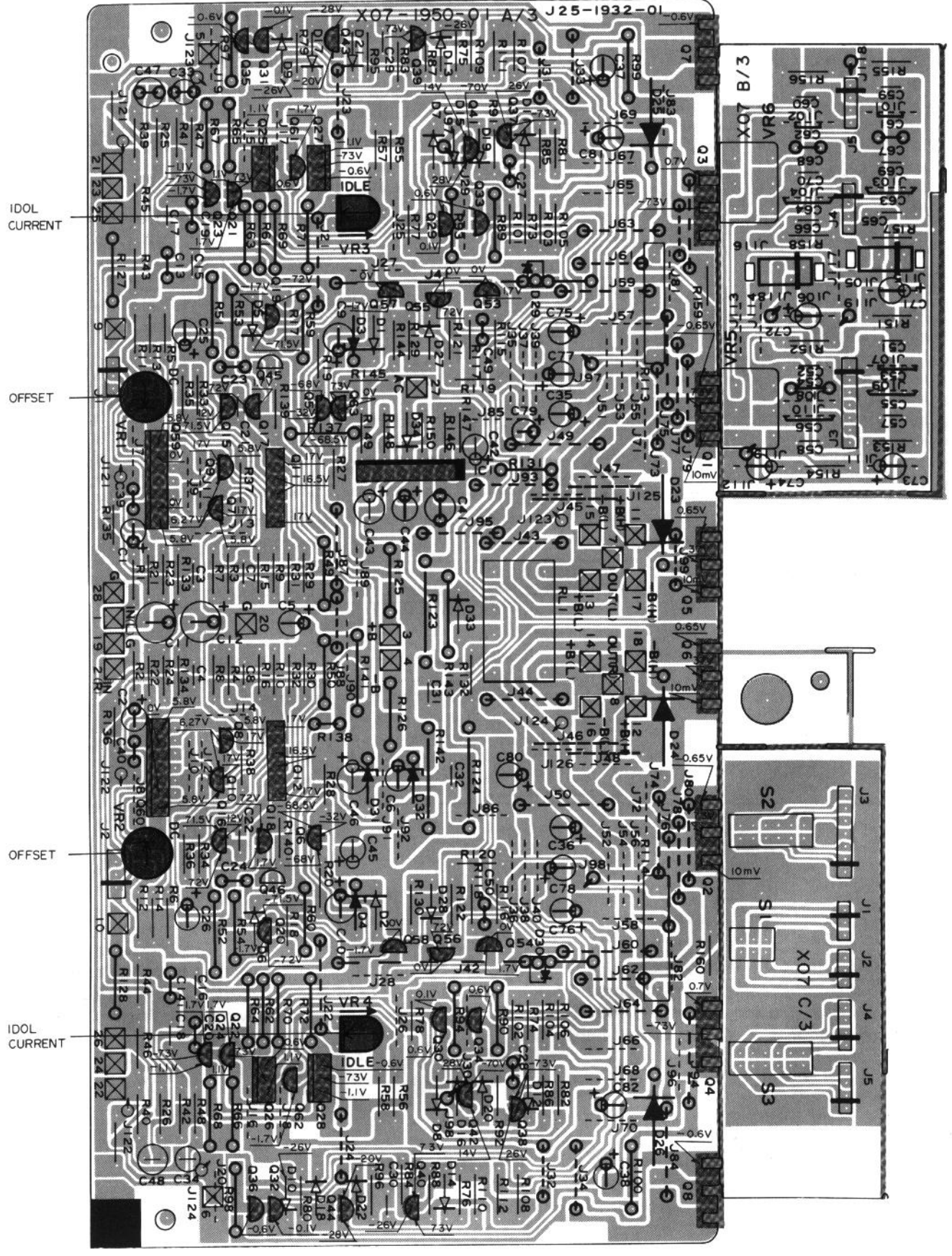

Refer to the schematic diagram for the values of resistors and capacitors.  
The PC board drawing is viewed from the side easy to check.

PC BOARD

PRE AMP (X08-1980-10) Component side view

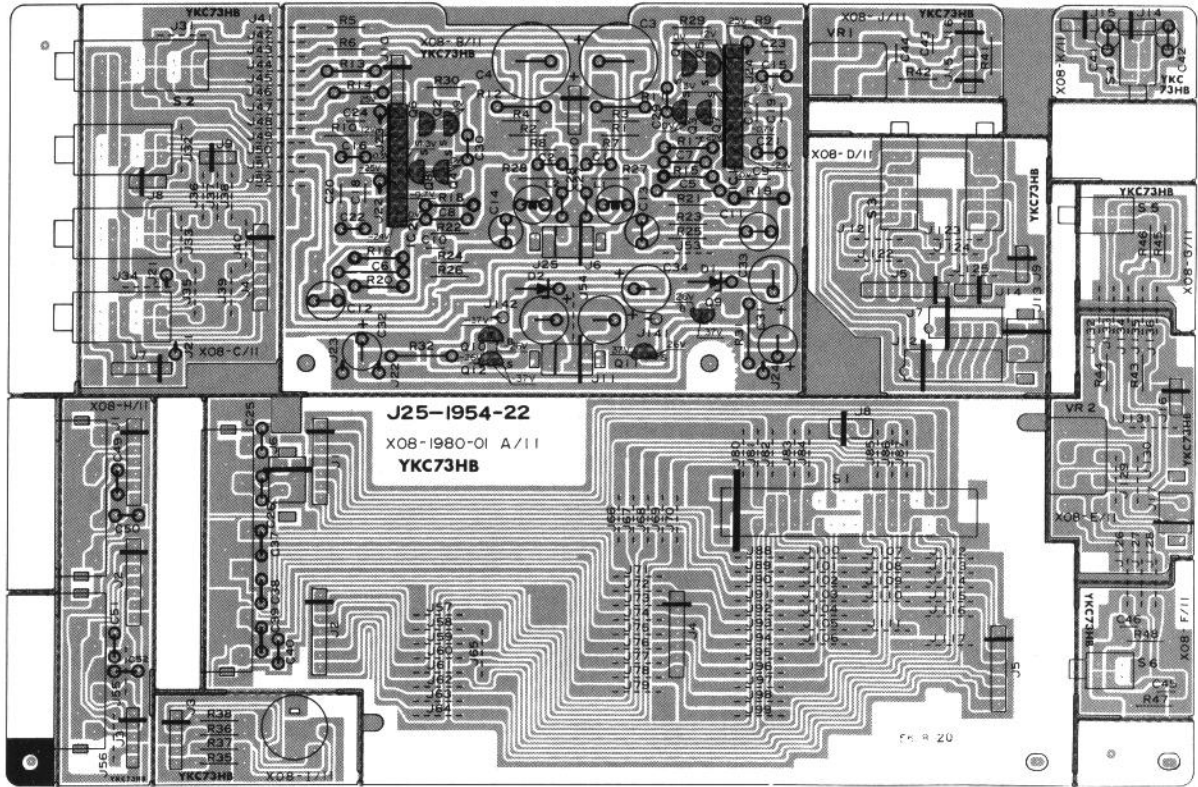

SUB (X13-3590-10) Component side view

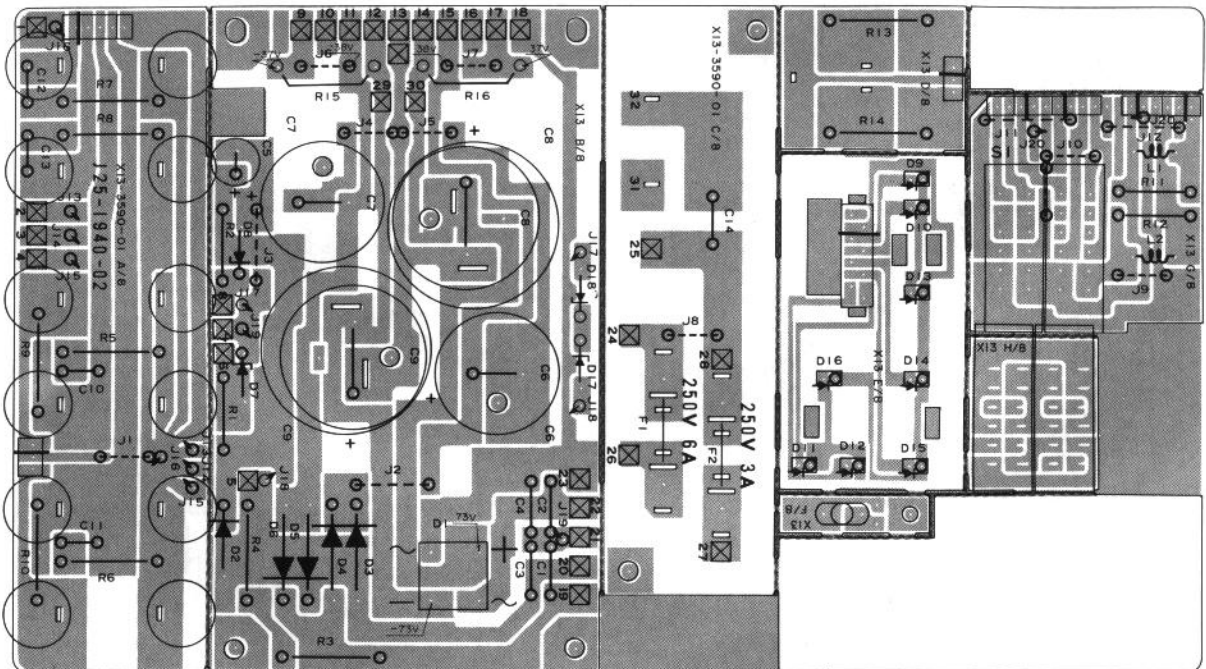

SUB (X13-3680-10) Component side view

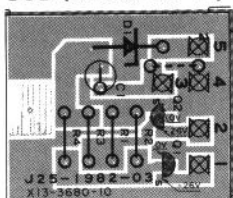

Refer to the schematic diagram for the values of resistors and capacitors.

The PC board drawing is viewed from the side easy to check.

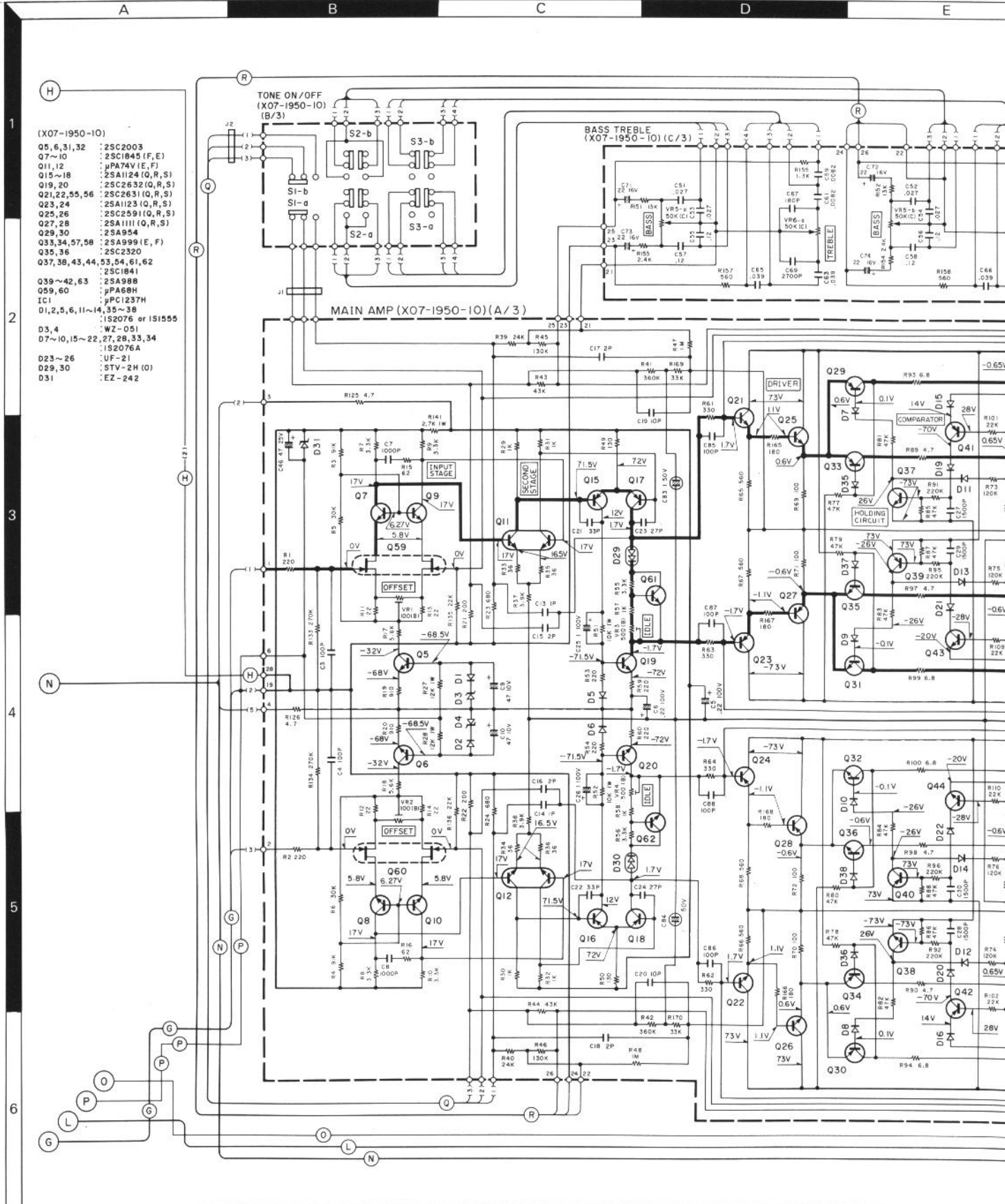

- (X07-1950-10)
- Q5, 6, 31, 32 : 2SC2003
  - Q7~10 : 2SC1845 (F, E)
  - Q11, 12 :  $\mu$ PA68H (E, F)
  - Q15~18 : 2SA1124 (Q, R, S)
  - Q19, 20 : 2SC2632 (Q, R, S)
  - Q21, 22, 55, 56 : 2SC2631 (Q, R, S)
  - Q23, 24 : 2SA1123 (Q, R, S)
  - Q25, 26 : 2SC2591 (Q, R, S)
  - Q27, 28 : 2SA1111 (Q, R, S)
  - Q29, 30 : 2SA954
  - Q33, 34, 57, 58 : 2SA999 (E, F)
  - Q35, 36 : 2SC2320
  - Q37, 38, 43, 44, 53, 54, 61, 62 : 2SC1841
  - Q39~42, 63 : 2SA988
  - Q59, 60 :  $\mu$ PA68H
  - IC1 :  $\mu$ PC1237H
- D1, 2, 3, 6, 11~14, 15~39 : 1S2076 or 1S1555
- D3, 4 : WZ-051
  - 07~10, 15~22, 27, 28, 33, 34 : 1S2076A
  - D23~26 : UF-21
  - D29, 30 : STV-2H (O)
  - D31 : EZ-242

- 2SA954
- 2SA988
- 2SA999
- 2SA1123
- 2SA1124
- 2SC1841
- 2SC1845
- 2SC2003
- 2SC2320
- 2SC2631
- 2SC2632

- 2SA957
- 2SA1111
- 2SC2167
- 2SC2591

- 2SA1095
- 2SC2565

- 2SB688
- 2SD718

- 2SK105
- 2SK163
- 2SK170

- $\mu$ PA68H

- $\mu$ PC1237H

- TA2010A

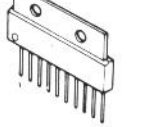
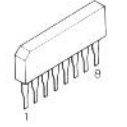
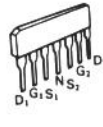
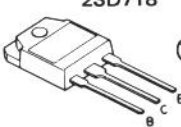
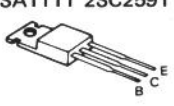
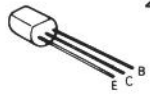



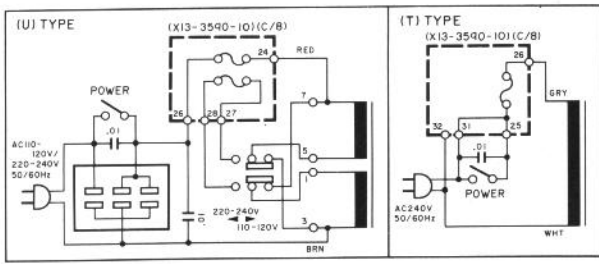
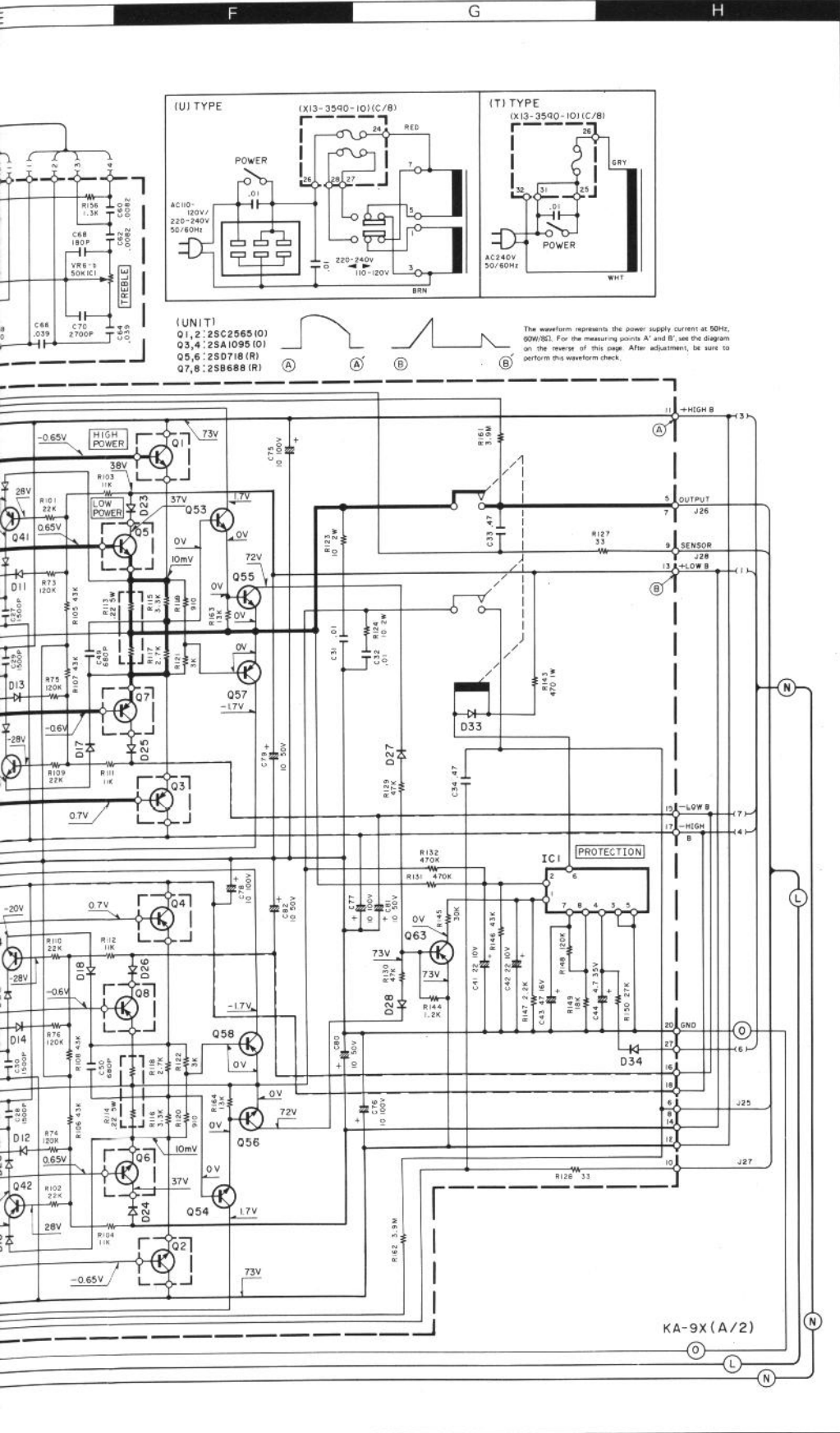

(U) TYPE  
 Q1,2: 2SC2565 (O)  
 Q3,4: 2SA1095 (O)  
 Q5,6: 2SD718 (R)  
 Q7,8: 2SB689 (R)

The waveform represents the power supply current at 50Hz, 60W/50L. For the measuring points A' and B', see the diagram on the reverse of this page. After adjustment, be sure to perform this waveform check.

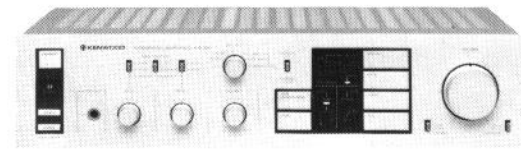

## SPECIFICATIONS

**Power output**

120 watts per channel minimum RMS, both channels driven, at 8 ohms from 20 Hz to 20,000 Hz with no more than 0.008% total harmonic distortion.

Both Channel Driven into 8 ohms at 1 kHz.....130 watts  
 Both Channel Driven into 4 ohms at 1 kHz.....170 watts  
 Dynamic Power Output into 4 ohms.....600 watts  
 Total Harmonic Distortion  
 (20 Hz to 20,000 Hz)  
 AUX input to SPEAKER output .....0.008% at rated power into 8 ohms  
 .....0.008% at 1/2 rated power into 8 ohms  
 Intermodulation Distortion .....0.008% at rated power into 8 ohms  
 (60 Hz:7 kHz = 4:1)  
 Damping Factor .....1,000 at 100 Hz

**Transient Response**

Rise Time .....1.7μs  
 Slew Rate .....±100 V/μs

**Frequency Response** .....DC to 200 kHz, -3 dB  
**Speaker Impedance** .....Accept 4 ohms to 16 ohms

**Input Sensitivity/Impedance**

Phono (MM) .....2.5 mV/47 kohms  
 Phono (MC) .....0.2 mV/100 ohms  
 Tuner, AUX, Tape A, B .....150 mV/47 kohms

**Signal-to-Noise Ratio (IHF, A)**

Phono (MM) .....87 dB for 2.5 mV input  
 .....93 dB for 5.0 mV input  
 .....99 dB for 10 mV input  
 Phono (MC) .....70 dB for 0.25 mV input  
 .....76 dB for 0.5 mV input  
 Tuner, AUX, Tape A, B .....107 dB for 150 mV input

**Maximum Input Level**

Phono (MM) .....250 mV (RMS), T.H.D. 0.008% at 1,000 Hz  
 Phono (MC) .....20 mV (RMS), T.H.D. 0.008% at 1,000 Hz

**Output Level/Impedance**

Tape REC (Pin) .....150 mV/330 ohms  
 (IDIN) .....30 mV/80 kohms

**Phono Frequency Response** .....RIAA standard curve +0.3 dB  
 (20 Hz to 20,000 Hz)

**Tone Control**

Bass Turnover Freq, 200 Hz .....±10 dB at 50 Hz  
 .....±10 dB at 100 Hz  
 400 Hz .....±10 dB at 100 Hz  
 Treble Turnover Freq, 3 kHz .....±10 dB at 10 kHz  
 .....±10 dB at 20 kHz  
 6 kHz .....±10 dB at 20 kHz

**Loudness Control** .....+10 dB at 100 Hz (at -30 dB VOLUME Level)  
**Subsonic Filter** .....18 Hz, 6 dB/oct

**GENERAL**

**Power Requirements** .....60 Hz 120 V (U.S.A. & Canada Model)  
 Model sold else where incorporates switches to accommodate 50/60 Hz 110-120 V/220-240 V

**Power Consumption** .....700 W (Rated power at 8 ohms)

**A.C. Outlets** .....Switched 2, Unswitched 1

**Dimensions** .....W 440 mm (17-5/16")  
 .....H 109 mm (4-19/64")  
 .....D 340 mm (13-25/64")

**Net Weight** .....10.2 kg (22.4 lb)

\* Measured pursuant to Federal Trade Commission's Trade Regulation rule on Power Output Claims for Amplifier in U.S.A.

Kenwood follows a policy of continuous advancements in development. For this reason specifications may be changed without notice.

Kenwood poursuit une politique de progrès constants en ce qui concerne le développement. Pour cette raison, les spécifications sont sujettes à modifications sans préavis.

Kenwood strebt ständige Verbesserungen in der Entwicklung an. Daher bleiben Änderungen der technischen Daten jederzeit vorbehalten.

TA2010A μPA74V

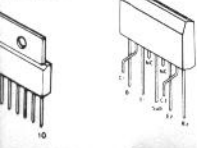

- DC voltages are measured by a VOM of 20kΩ/V input impedance.
- Les tensions de courant continu sont mesurées par un multimètre d'une impédance d'entrée de 20kΩ/V.
- Die Gleichstrom-Spannungen werden durch ein Vielfachmeßgerät von 20kΩ/V Eingangs-Impedanz gemessen.

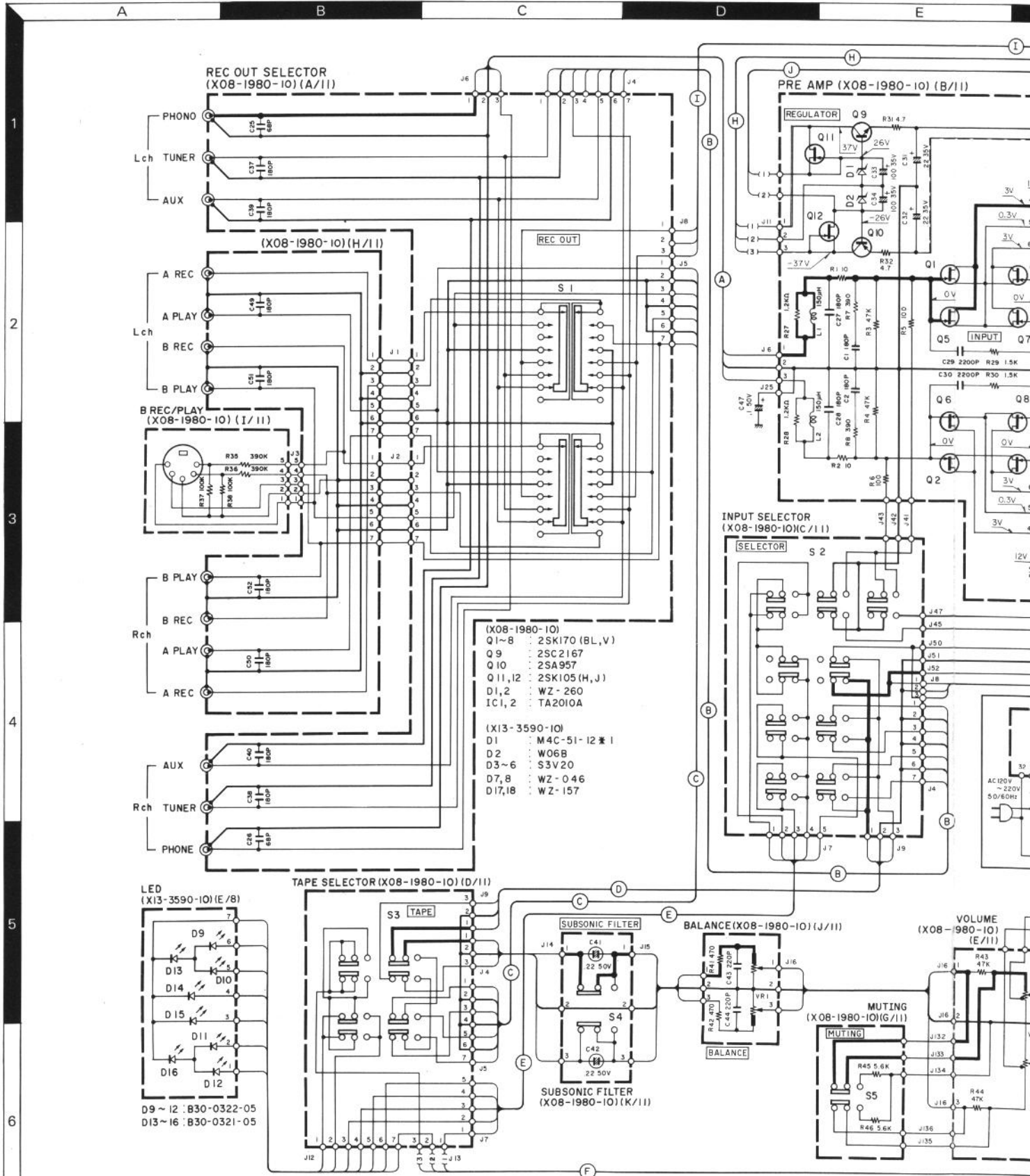

2SA954 2SC1845  
 2SA988 2SC2003  
 2SA999 2SC2320  
 2SA1123 2SC2631  
 2SA1124 2SC2632  
 2SC1841

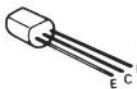

2SA957  
 2SA1111  
 2SC2167  
 2SC2591

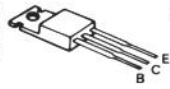

2SA1095  
 2SC2565



2SB688  
 2SD718

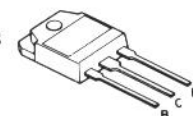

2SK105  
 2SK163  
 2SK170

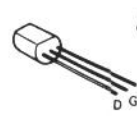

μPA68H



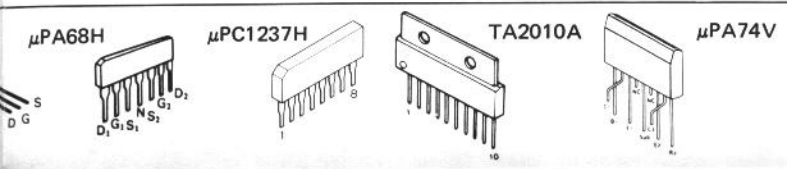
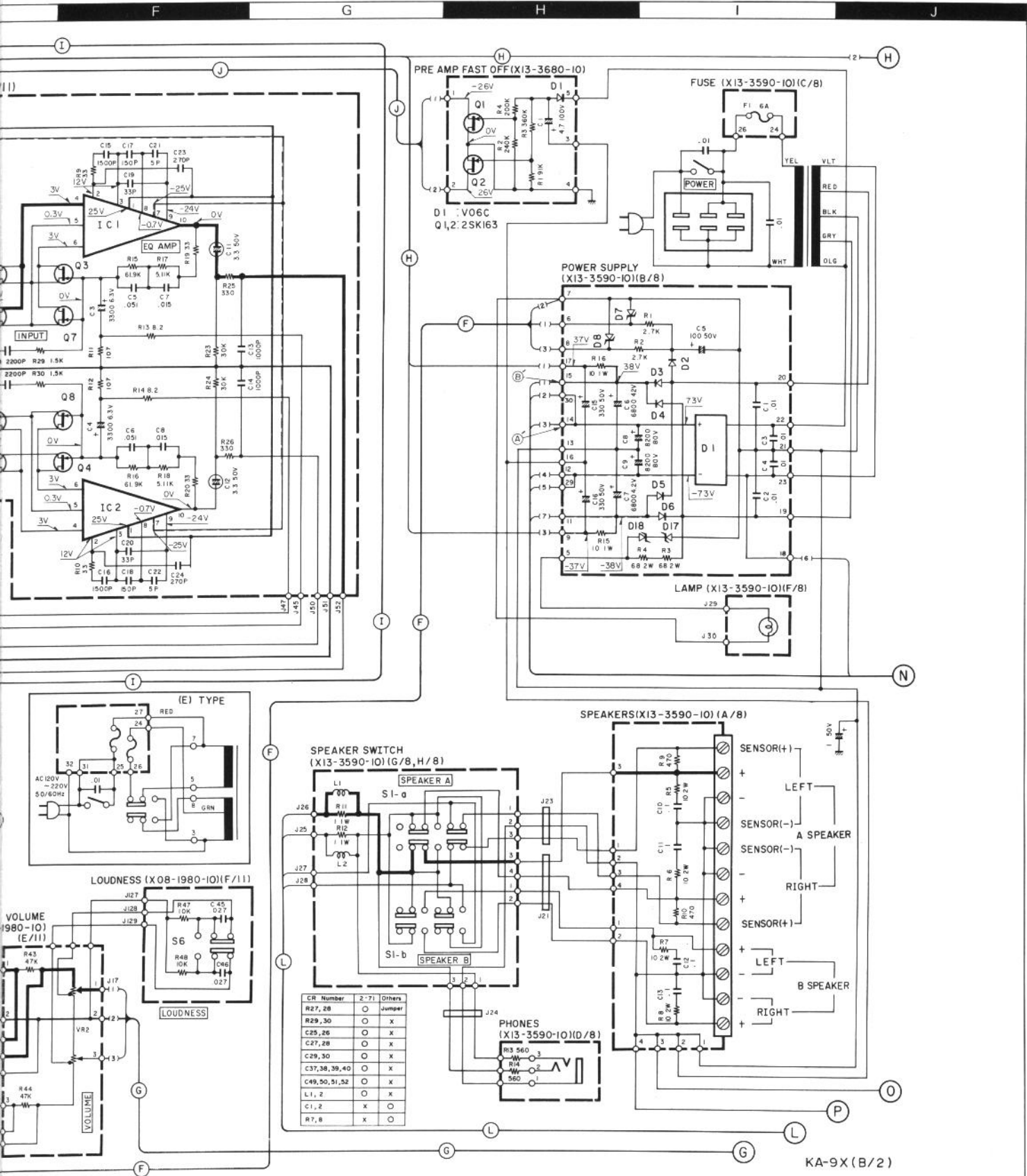

- DC voltages are measured by a VOM of 20kΩ/V input impedance.
- Les tensions de courant continu sont mesurées par un multimètre d'une impédance d'entrée de 20kΩ/V.
- Die Gleichstrom-Spannungen werden durch ein Vielfachmeßgerät von 20kΩ/V Eingangs-Impedanz gemessen.